

**Submittal Data: TW24HQ2A1D** 24,000 Btu/h Wall Mounted Heat Pump System

Job Name \_\_\_\_\_ Location \_\_\_\_\_ Date \_\_\_\_\_

Purchaser \_\_\_\_\_ Engineer \_\_\_\_\_

Submitted To \_\_\_\_\_ For  Reference  Approval  Construction

Unit Designation \_\_\_\_\_ Schedule No. \_\_\_\_\_

**GENERAL FEATURES**

- Compact and Quiet Design
- High Efficiency DC Inverter Technology
- Vertical Swing Louver
- Wireless Remote with LCD Display
- Wired Controller ( Sold Separately)
- Low Ambient Cool to 0 deg F
- Gold Fin Condenser Coil



**System Ratings** **Indoor Unit Data**

<b>Cooling</b>		
Rated Capacity		22,000 Btu/h
Capacity Range		6,824-27,296 Btu/h
Power Input (Max)		3,000 W
SEER		20.0
EER		12.5
<b>Heating at 47° F</b>		
Rated Capacity		23,000 Btu/h
Capacity Range		6,824-30,708 Btu/h
Power Input (Max)		3,000 W
HSPF		10.0
COP		3.4
<b>Heating at 17° F</b>		
Rated Capacity		15,923 Btu/h
<b>Operating Range</b>		
Cooling	(Max)	115°F (46 C)
	(Min)	0°F (-18 C)
Heating	(Max)	75°F (24 C)
	(Min)	-4°F (-20 C)

<b>Fan Motor</b>	<b>Type</b>	<b>Cross-Flow</b>
	Output Power	60 W
	FLA	0.4 A
<b>Airflow</b>		
Cooling	Wet (Lo/Hi)	530/706 CFM
Heating	Dry (Lo/Hi)	530/706 CFM
<b>Sound Pressure Level</b>		
Cooling	(Min/Max)	36/48 db(A)
Heating	(Min/Max)	36/48 db(A)
<b>Dehumidification</b>		4.23 pt/hr

**Refrigerant Piping Data** **Outdoor Unit Data**

Gas Pipe Size (OD)	5/8-in
Liquid Pipe Size (OD)	1/4-in
Connection Method	Flared
MAX Refrigerant Pipe Length	82-ft
MIN Refrigerant Pipe Length	10-ft
MAX Refrigerant Pipe Elevation	33-ft

<b>Compressor</b>	<b>Type</b>	DC Inverter Driven Rotary
	RLA	11.5 A
<b>Refrigerant Type</b>		R410A
<b>Fan Motor</b>	<b>Output Power</b>	92 W
	FLA	0.65 A
<b>Sound Pressure</b>		
Cooling/Heating		59/59 db(A)
<b>Power Supply</b>		
Normal Operational Voltage		208/230 V, 1 Phase, 60 Hz
Voltage Range		187 - 253 V
MCA		20.0 A
MOCP/Breaker Size		30 A

**COOLING PERFORMANCE (Btu/h)\***

Outdoor Ambient DB	Indoor Ambient Temperature							
	68F DB (20C)		73F DB (23C)		80F DB (27C)		82F DB (28C)	
	57F WB (14C)		61F WB (16C)		67F WB (19C)		68F WB (20C)	
	TC	SHC	TC	SHC	TC	SHC	TC	SHC
5°F	11,904	9,336	12,576	9,859	14,193	11,132	14,619	11,402
14°F	14,285	11,204	15,091	11,831	17,031	13,358	17,542	13,683
23°F	15,651	12,277	16,740	13,131	19,181	15,044	19,756	15,410
32°F	16,198	12,707	17,326	13,591	19,852	15,570	20,448	15,949
41°F	16,765	13,151	17,933	14,066	20,547	16,115	21,163	16,507
50°F	17,352	13,612	18,560	14,559	21,266	16,679	21,904	17,085
59°F	18,979	14,885	20,300	15,921	22,233	17,433	22,900	17,862
68°F	21,494	16,858	22,838	17,909	24,405	19,141	25,137	19,607
77°F	21,241	16,662	22,592	17,720	24,181	18,967	24,907	19,427
86°F	20,196	15,838	21,539	16,896	23,510	18,438	24,215	18,888
95°F	19,114	14,991	20,450	16,034	22,390	17,561	23,062	17,988
104°F	18,188	14,265	19,517	15,308	21,808	17,108	22,462	17,520
113°F	17,255	13,532	18,584	14,575	20,882	16,374	21,509	16,777

**HEATING PERFORMANCE (Btu/h)\***

Outdoor Ambient DB	Indoor Ambient Temperature							
	68F DB (20C)		73F DB (23C)		80F DB (27C)		86F DB (30C)	
	57F WB (14C)		61F WB (16C)		67F WB (19C)		72F WB (22C)	
	TC	SHC	TC	SHC	TC	SHC	TC	SHC
-4°F	13068	13068	12848	12848	12465	12465	12329	12329
0°F	14160	14160	13924	13924	13509	13509	13351	13351
6°F	14938	14938	14687	14687	14249	14249	14082	14082
10°F	15559	15559	15300	15300	14844	14844	14671	14671
16°F	16030	16030	15763	15763	15293	15293	15111	15111
19°F	16337	16337	16070	16070	15591	15591	15402	15402
24°F	18176	18176	17901	17901	17367	17367	17240	17240
32°F	20313	20313	20038	20038	19441	19441	19378	19378
41°F	22757	22757	22490	22490	21819	21819	21822	21822
43°F	23370	23370	23095	23095	22406	22406	22435	22435
47°F	23516	23516	23108	23108	22420	22420	22104	22104
53°F	23749	23749	23334	23334	22639	22639	22323	22323
59°F	24294	24294	23865	23865	23154	23154	22832	22832
64°F	24811	24811	24374	24374	23648	23648	23319	23319
70°F	25277	25277	24840	24840	24100	24100	23763	23763
75°F	25633	25633	25182	25182	24432	24432	24091	24091

\* Maximum system capacity

TC- Total Capacity ( BtuH)

SHC- Sensible Capacity (BtuH)

MINIMUM SPACING REQUIREMENTS

Units: inch (mm)

INDOOR

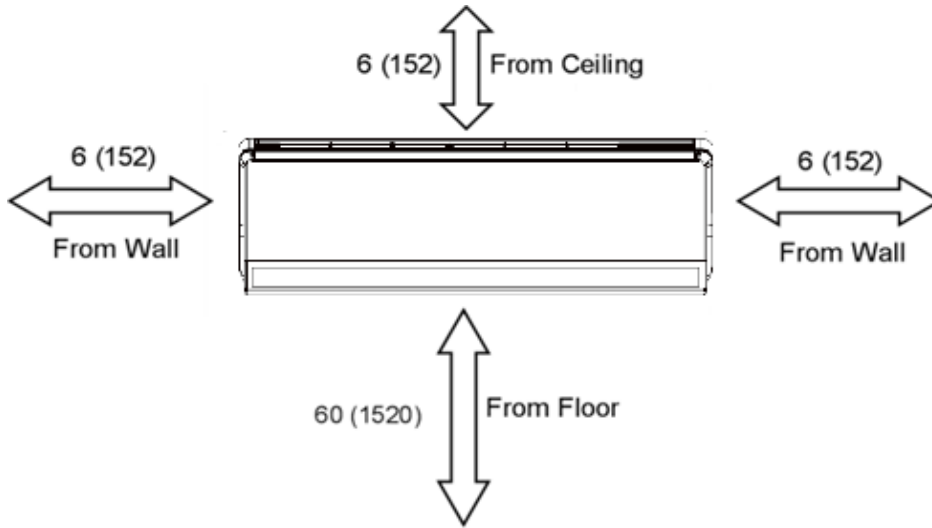

Units: inch (mm)

OUTDOOR

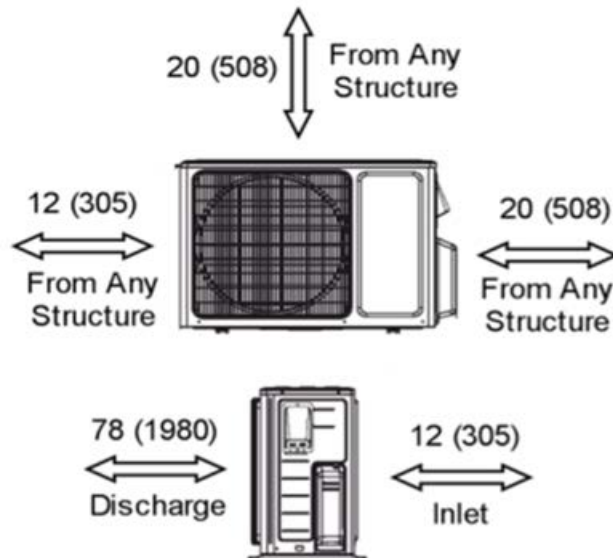

## DIMENSIONAL SPECIFICATIONS

## TW24HQ2A1D

### INDOOR UNIT DIMENSIONS

Units: inch

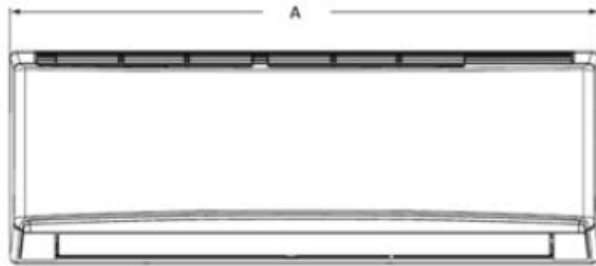

Dimensions	
A	42.4
B	12.8
C	9.7

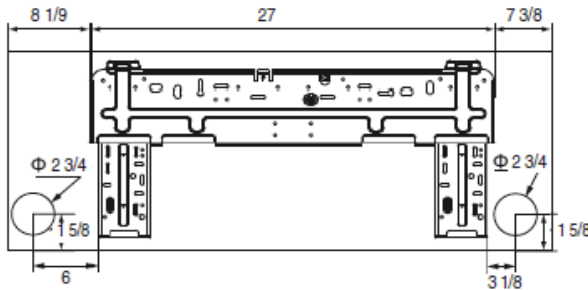

Weight (Net/Gross) 34.2/41.9 lbs

Liquid Line Valve	1/4-in OD Flared
Gas Line Valve	5/8-in OD Flared
Drain Connector	5/8-in OD

### OUTDOOR UNIT DIMENSIONS

Units: inch

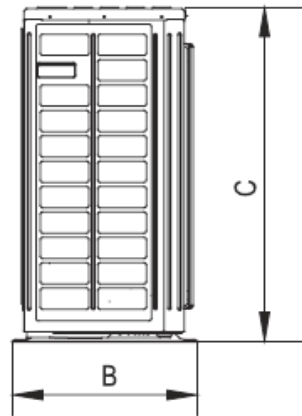
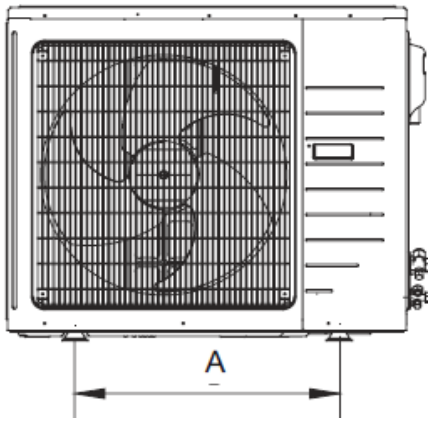

Dimensions	
A	24.0
B	16.8
C	31.1
D	38.6
D	16.8

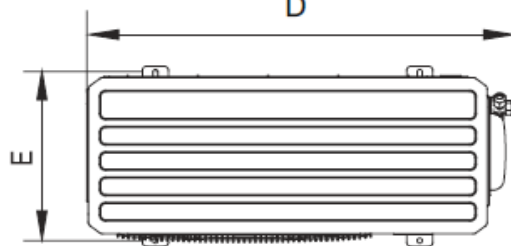

Weight (Net/Gross) 142.0/153.0 lbs

Liquid Line Valve	1/4-in OD Flared
Gas Line Valve	5/8-in OD Flared

**Notes:**

1. Recommended Interconnecting Cable Type 14 AWG 4 Stranded Bare Copper Conductors THHN 600V Wire
2. Power wiring cable size must comply with applicable national and local codes.
3. Test conditions are based on AHRI 210/240.