

VRF Indoor	MODEL: TVRF-IEHESP D30KHP	<b>TOSOT</b>
------------	---------------------------	--------------

Job Name: \_\_\_\_\_  
 Engineer Name: \_\_\_\_\_  
 System No: \_\_\_\_\_

Location: \_\_\_\_\_  
 Contractor: \_\_\_\_\_  
 Date: \_\_\_\_\_

**Indoor VRF SYSTEM FEATURES**

- High Static Pressure Design
- Easy Maintenance
- Convenient Installation
- Protection Functions



Specifications		Model Name
Unit Type		TVRF-IEHESP D30KHP
Cooling Capacity	Btu/h	30,000
Heating Capacity	Btu/h	34,000
External Dimensions (WxHxD)	In.	48-3/8 x 11-3/8 x 30-1/2
	mm	1229 x 290 x 775
Net Weight	Lbs. / Kg	104/47
Electrical Power Requirements	Voltage, Phase, Hertz	208/230V, 1-phase, 60HZ
Power Cooling Consumption	kW	0.2
Power Heating Consumption	kW	0.2
Current Cooling	A	1.4
Current Heating	A	1.4
Minimum Circuit Ampacity (MCA)	A	3.15
Max. Overcurrent Protection (MOCP) Fuse	A	6
Refrigerant Piping Dimensions (In./mm)	Liquid (High Pressure)	3/8 - 9.52
	Gas (Low Pressure)	5/8 - 15.9
Sound Pressure Level	dB(A)	46/44/42
<b><u>Fan</u></b>		
Type x Quantity		Centrifugal x 2
Airflow Rate	CFM	1000/853/650
<b><u>Motor</u></b>		
Motor Type x Quantity		Direct Drive x 1
Motor Output	kW	0.25
Refrigerant		R410A
Coil Type		internal groove tube

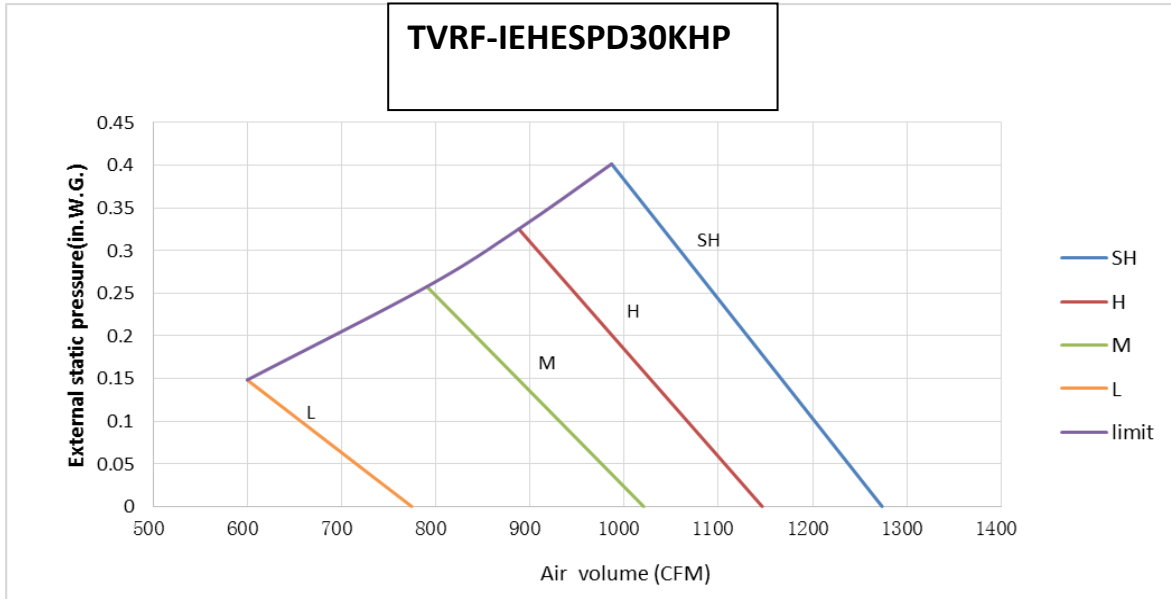

### Outline Dimension Diagram

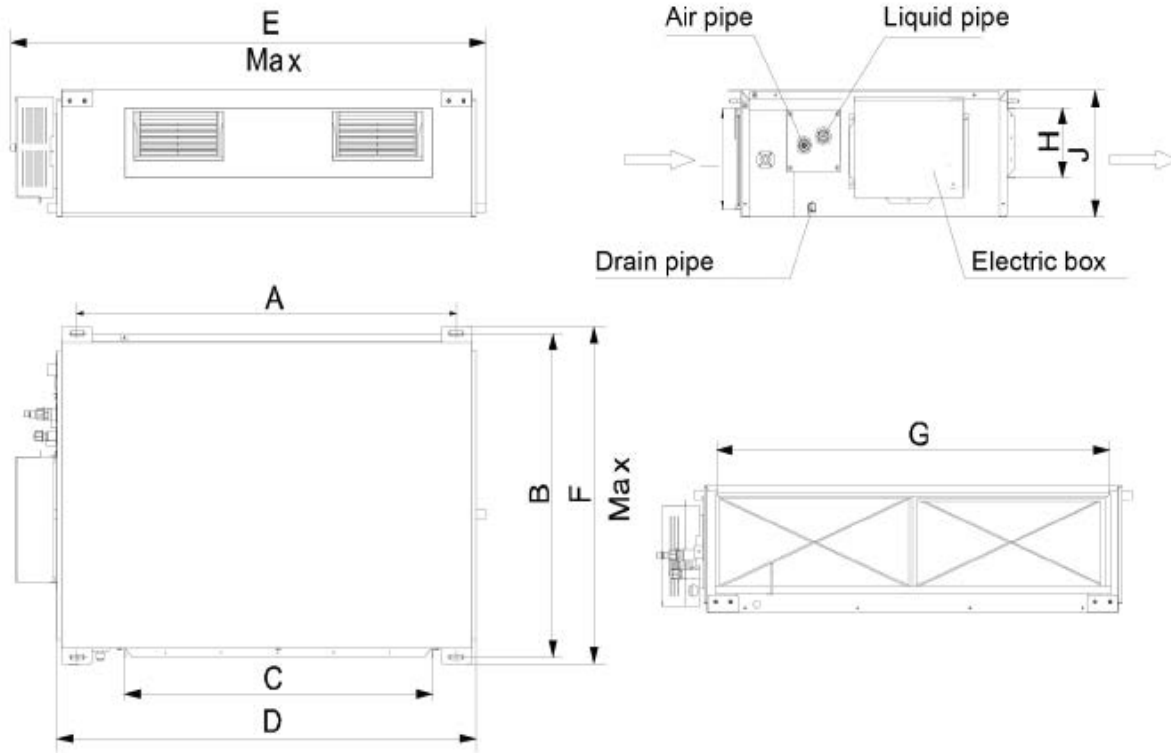

	A	B	C	D	E
mm	1011	748	820	1115	1229
inch	43 3/8	29 1/2	32 1/4	43 7/8	48 3/8
	F	G	H	I	J
mm	775	979	160	231	290
inch	30 1/2	38 1/2	6 1/4	9 1/8	11 3/8



5965 Chemin de la Côte de Liesse  
Saint Laurent, QC, Canada, H4T 1C3

Contact: +1 438 792 1956

[info@tosotusa.com](mailto:info@tosotusa.com)

[www.tosotusa.com](http://www.tosotusa.com)