

Single zone inverter mini split

MODEL: TW09CQ1A5D

TOSOT

Job Name:

Location:

Engineer Name:

File Resubmit

Contractor:

System No:

Approval Other

Date:

General Features

- Smart 1 Hertz Inverter Technology
- Low Ambient Cooling to 5 °F
- Multiple Fan Speeds
- Memory Function
- Fan Delay Function
- Intelligent Pre-heating / Defrost
- LED display
- Control lock
- High And Low Pressure Protection Features
- Load Protection Features
- Over-Current Protection
- Anti Freeze Protection



Unit Performance:

<i>Cooling:</i>	
Capacity (Min-Rated-Max, Btu/h)	3,099-9,000-9,599
SEER	16
EER	10
<i>Heating:</i>	
Capacity (Min-Rated-Max, Btu/h)	N/A
HSPF	N/A
COP (Btu/h)/w	N/A

Unit Specification

Refrigerant Type	R410A
Refrigerant Charge (oz)	24.7
ODU Sound Pressure (dB(A))	52
IDU Sound Pressure (dB(A))	43/38/34/28
ODU Net Weight (lbs)	66.2
IDU Net Weight (lbs)	20

Fan

ODU / IDU Type	Axial-flow/Cross-flow
Quantity (ODU + IDU)	1+1
Motor/Drive	Direct Drive
ODU Max Air Flow Rate (CFM)	1599
IDU Air Flow Rate (CFM)	171 / 318

Compressor

Cooling Operation Ambient temp. Range	0~115 °F
Heating Operation Ambient temp. Range	N/A
Compressor Type	Swing
Fan Motor Output (W)	30
Crankcase Heater	Yes

Electrical Specification

Power Supply	208-230V / 60Hz
Communications Wire Size	AWG 14/4
MOP (A)	15
MCA (A)	9
Cooling Rated Amps (A)	5.8
Heating Rated Amps (A)	N/A
Compressor RLA (A)	4
Indoor Fan Motor RLA(A)	0.215
Outdoor Fan Motor RLA(A)	0.36
Nominal Cooling Power Input (kW)	0.9
Nominal Heating Power Input (kW)	N/A

Piping

Liquid Line (in, OD)	1/4
Gas Line (in, OD)	3/8
Additional Refrigerant (oz./ft.)	0.2
Max Pipe Length (ft.)	49.2
Piping Length (no add'l refrigerant, ft.)	24.6
Max Elevation (ft.)	32.8

AHRI certification Ref #



Capacity Variation Ratio According to Temperature

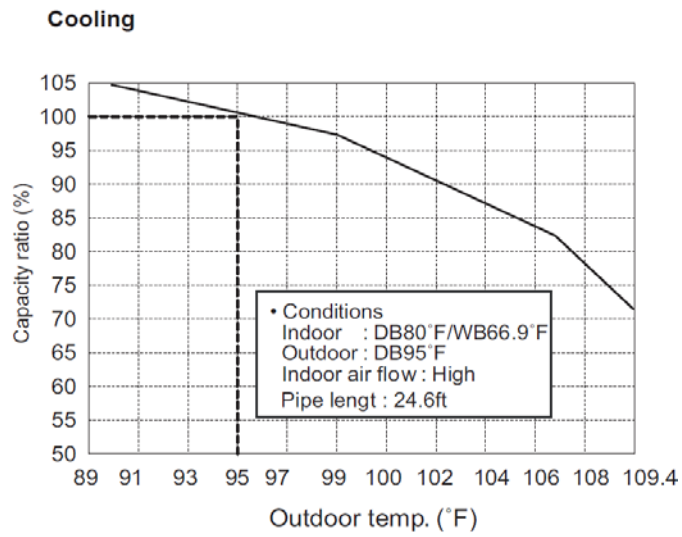

Single zone inverter mini split

MODEL: TW09CQ1A5D

TOSOT

Outline Dimension Diagram

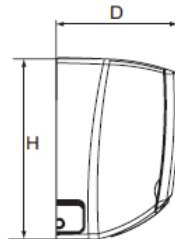
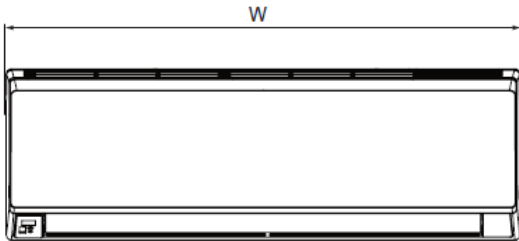

W	H	D
31 1/9	10 5/6	7 7/8

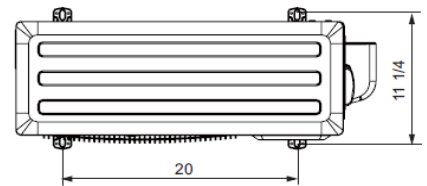
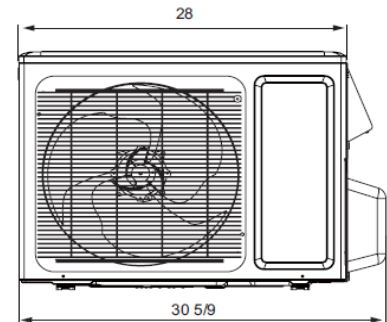
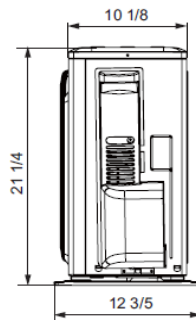
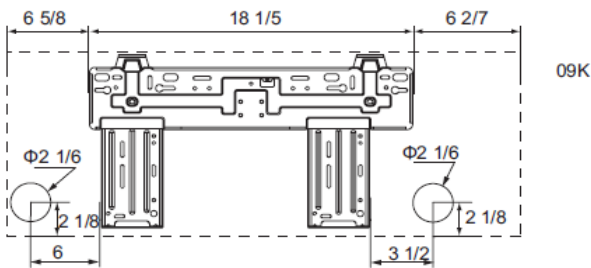

GLOSSARY

SEER - Seasonal Energy Efficiency Ratio

EER - Energy Efficiency Ratio

HSPF - Heating Seasonal Performance Factor

MOP - Maximum Overcurrent Protection

MCA - Minimum Circuit Ampacity

TOSOT

5965 Chemin de la Côte de Liesse
Saint laurent, QC, Canada, H4T 1C3

Contact: +1 438 792 1956

info@tosotusa.com

www.tosotusa.com