

Single zone inverter mini split

MODEL: TW09HQ1A5D

TOSOT

Job Name:

Engineer Name:

System No:

- File Resubmit
 Approval Other

Location:

Contractor:

Date:

General Features

- Smart 1 Hertz Inverter Technology
- Low Ambient Cooling to 5 °F
- Multiple Fan Speeds
- Memory Function
- Fan Delay Function
- Intelligent Pre-heating / Defrost
- LED display
- Control lock
- High And Low Pressure Protection Features
- Load Protection Features
- Over-Current Protection
- Anti Freeze Protection



Unit Performance:

<i>Cooling:</i>	
Capacity (Min-Rated-Max, Btu/h)	3,099-9,000-9,599
SEER	16
EER	10
<i>Heating:</i>	
Capacity (Min-Rated-Max, Btu/h)	3,100-9,500-12,000
HSPF	9
COP (W/W)	3.48

Unit Specification

Refrigerant Type	R410A
Refrigerant Charge (oz)	24.7
ODU Sound Pressure (dB(A))	52
IDU Sound Pressure (dB(A))	43/38/34/28
ODU Net Weight (lbs)	65
IDU Net Weight (lbs)	20
Dehumidifying (Pint/h)	1.69

Fan

ODU / IDU Type	Axial-flow/Cross-flow
Quantity (ODU + IDU)	1+1
Motor/Drive	Direct Drive
ODU Max Air Flow Rate (CFM)	942
IDU Air Flow Rate (CFM)	171 / 318

Compressor

Cooling Operation Ambient temp. Range	0~115 °F
Heating Operation Ambient temp. Range	-5~75 °F
Compressor Type	Swing
Fan Motor Output (W)	30
Crankcase Heater	Yes

Electrical Specification

Power Supply	208-230V / 60Hz
Communications Wire Size	AWG 16
MOP (A)	15
MCA (A)	9
Cooling Rated Amps (A)	5.8
Heating Rated Amps (A)	6
Compressor RLA (A)	4
Indoor Fan Motor RLA (A)	0.22
Outdoor Fan Motor RLA(A)	0.36
Nominal Cooling Power Input (kW)	0.9
Nominal Heating Power Input (kW)	0.8

Piping

Liquid Line (in, OD)	1/4
Gas Line (in, OD)	3/8
Additional Refrigerant (oz./ft.)	0.215
Max Pipe Length (ft.)	49.2
Piping Length (no add'l refrigerant, ft.)	24.6
Max Elevation (ft.)	32.8

AHRI certification Ref #	9110195
--------------------------	---------



Capacity Variation Ratio According to Temperature

Cooling

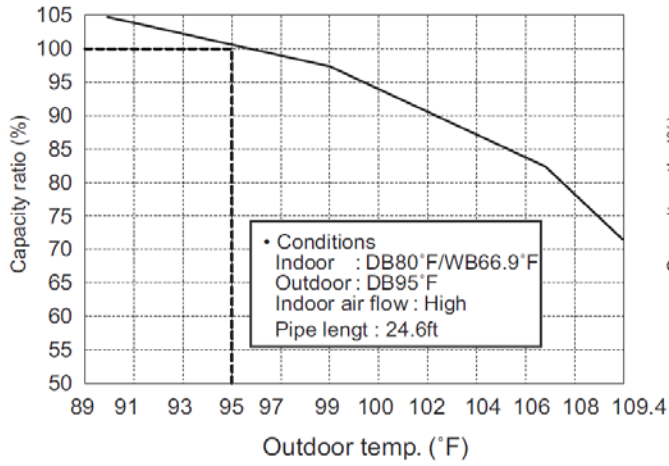

Heating

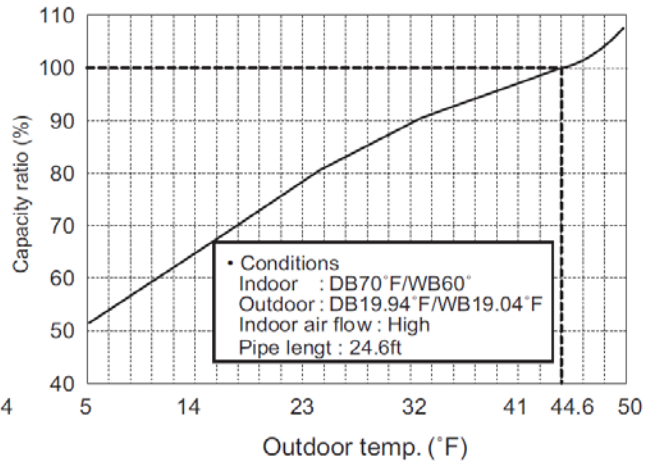

Single zone inverter mini split

MODEL: TW09HQ1A5D

TOSOT

Outline Dimension Diagram

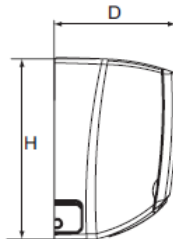
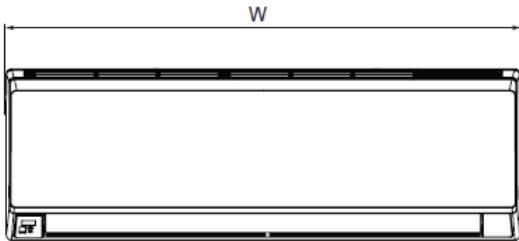

W	H	D
31 1/9	10 5/6	7 7/8

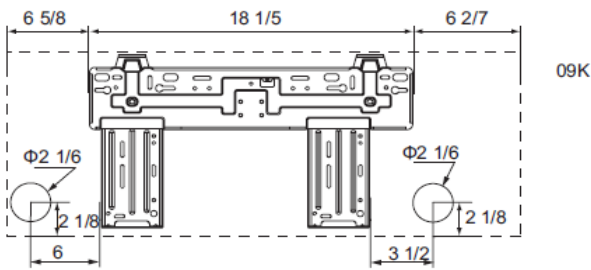

09K

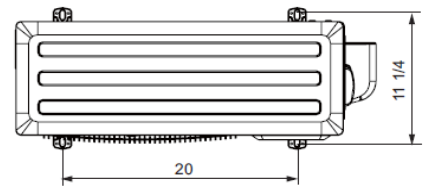
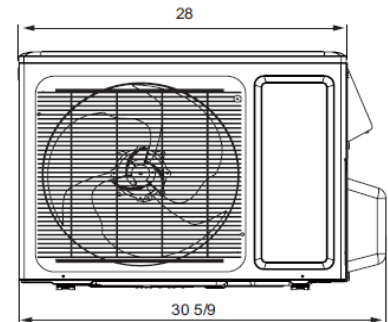
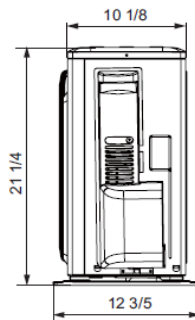

GLOSSARY

SEER - Seasonal Energy Efficiency Ratio

EER - Energy Efficiency Ratio

HSPF - Heating Seasonal Performance Factor

MOP - Maximum Overcurrent Protection

MCA - Minimum Circuit Ampacity

TOSOT

5965 Chemin de la Côte de Liesse
Saint laurent, QC, Canada, H4T 1C3

Contact: +1 438 792 1956

info@tosotusa.com

www.tosotusa.com