

Single zone inverter mini split

MODEL: TW24CQ1A5D

TOSOT

Job Name:

Location:

Engineer Name:

File Resubmit

Contractor:

System No:

Approval Other

Date:

General Features

- Smart 1 Hertz Inverter Technology
- Low Ambient Cooling to 5 °F
- Multiple Fan Speeds
- Memory Function
- Fan Delay Function
- Intelligent Pre-heating / Defrost
- LED display
- Control lock
- High And Low Pressure Protection Features
- Load Protection Features
- Over-Current Protection
- Anti Freeze Protection



Unit Performance:

<i>Cooling:</i>	
Capacity (Min-Rated-Max, Btu/h)	8,630-22,000-23,200
SEER	16
EER	9.73
<i>Heating:</i>	
Capacity (Min-Rated-Max, Btu/h)	N/A
HSPF	N/A
COP (Btu/h)/w	N/A

Unit Specification

Refrigerant Type	R410A
Refrigerant Charge (oz)	56.45
ODU Sound Pressure (dB(A))	59
IDU Sound Pressure (dB(A))	48/44/40/36
ODU Net Weight (lbs)	103.6
IDU Net Weight (lbs)	37.5

Fan

ODU / IDU Type	Axial-flow/Cross-flow
Quantity (ODU + IDU)	1+1
Motor/Drive	Direct Drive
ODU Max Air Flow Rate (CFM)	3200
IDU Air Flow Rate (CFM)	530 / 706

Compressor

Cooling Operation Ambient temp. Range	0~115 °F
Heating Operation Ambient temp. Range	N/A
Compressor Type	Rotary
Fan Motor Output (W)	60
Crankcase Heater	Yes

Electrical Specification

Power Supply	208-230V / 60Hz
Communications Wire Size	AWG 14/4
MOP (A)	25
MCA (A)	16
Cooling Rated Amps (A)	12
Heating Rated Amps (A)	N/A
Compressor RLA (A)	7.2
Indoor Fan Motor RLA(A)	0.32
Outdoor Fan Motor RLA(A)	0.4
Nominal Cooling Power Input (kW)	2.26
Nominal Heating Power Input (kW)	N/A

Piping

Liquid Line (in, OD)	1/4
Gas Line (in, OD)	5/8
Additional Refrigerant (oz./ft.)	0.2
Max Pipe Length (ft.)	82
Piping Length (no add'l refrigerant, ft.)	24.6
Max Elevation (ft.)	32.8

AHRI certification Ref #



Single zone inverter mini split

MODEL: TW24CQ1A5D

TOSOT

Capacity Variation Ratio According to Temperature

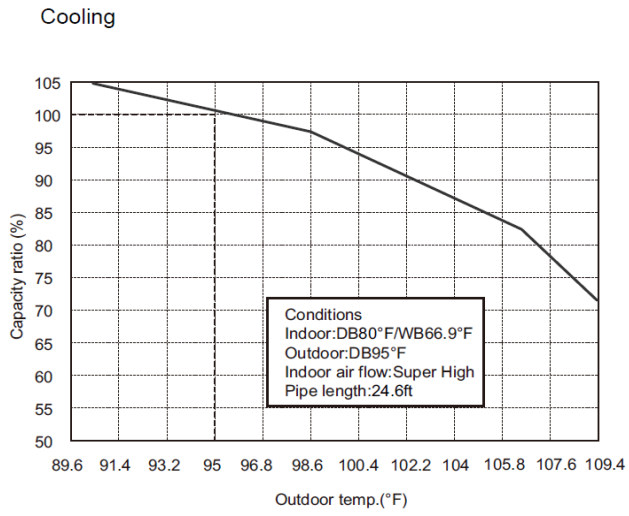

Single zone inverter mini split

MODEL: TW24CQ1A5D

TOSOT

Outline Dimension Diagram

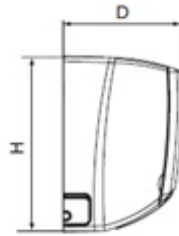
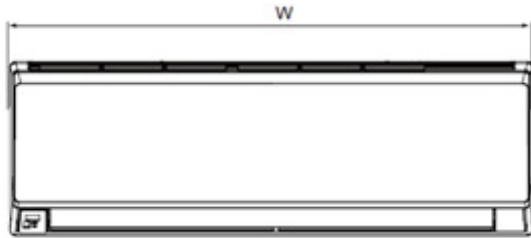

W	H	D
42 4/9	12 4/5	9 2/3

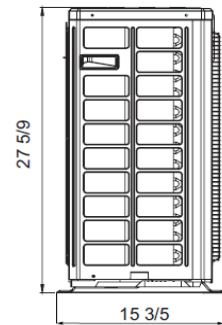
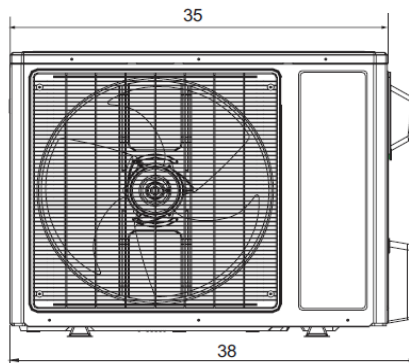
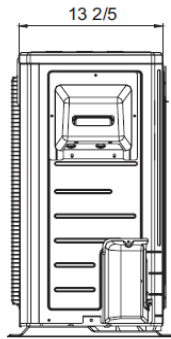
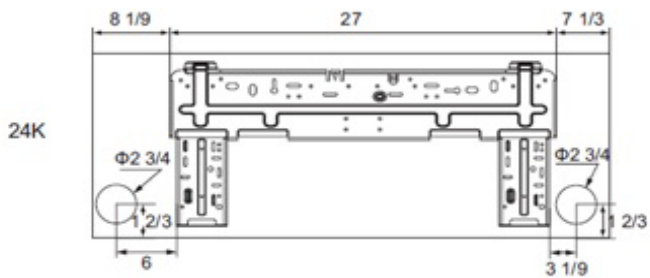

Unit: inch

GLOSSARY

SEER - Seasonal Energy Efficiency Ratio

EER - Energy Efficiency Ratio

HSPF - Heating Seasonal Performance Factor

MOP - Maximum Overcurrent Protection

MCA - Minimum Circuit Ampacity

TOSOT

5965 Chemin de la Côte de Liesse
Saint laurent, QC, Canada, H4T 1C3

Contact: +1 438 792 1956

info@tosotusa.com

www.tosotusa.com