

Single zone inverter mini split

MODEL: TW24HQ1A5D

TOSOT

Job Name:

Engineer Name:

System No:

- File Resubmit
 Approval Other

Location:

Contractor:

Date:

General Features

- Smart 1 Hertz Inverter Technology
- Low Ambient Cooling to 5 °F
- Multiple Fan Speeds
- Memory Function
- Fan Delay Function
- Intelligent Pre-heating / Defrost
- LED display
- Control lock
- High And Low Pressure Protection Features
- Load Protection Features
- Over-Current Protection
- Anti Freeze Protection



Unit Performance:

<i>Cooling:</i>	
Capacity (Min-Rated-Max, Btu/h)	8,630-22,000-23,200
SEER	16
EER	9.73
<i>Heating:</i>	
Capacity (Min-Rated-Max, Btu/h)	8,650-23,000-26,000
HSPF	9
COP (W/W)	2.93

Unit Specification

Refrigerant Type	R410A
Refrigerant Charge (oz)	65.3
ODU Sound Pressure (dB(A))	59
IDU Sound Pressure (dB(A))	48/44/40/36
ODU Net Weight (lbs)	110
IDU Net Weight (lbs)	37.485
Dehumidifying (Pint/h)	5.28

Fan

ODU / IDU Type	Axial-flow/Cross-flow
Quantity (ODU + IDU)	1+1
Motor/Drive	Direct Drive
ODU Max Air Flow Rate (CFM)	1883
IDU Air Flow Rate (CFM)	530 / 706

Compressor

Cooling Operation Ambient temp. Range	0~115 °F
Heating Operation Ambient temp. Range	-5~75 °F
Compressor Type	Rotary
Fan Motor Output (W)	60
Crankcase Heater	Yes

Electrical Specification

Power Supply	208-230V / 60Hz
Communications Wire Size	AWG 14
MOP (A)	25
MCA (A)	16
Cooling Rated Amps (A)	12
Heating Rated Amps (A)	12.2
Compressor RLA (A)	7.2
Indoor Fan Motor RLA (A)	0.32
Outdoor Fan Motor RLA(A)	0.4
Nominal Cooling Power Input (kW)	2.26
Nominal Heating Power Input (kW)	2.3

Piping

Liquid Line (in, OD)	1/4
Gas Line (in, OD)	5/8
Additional Refrigerant (oz./ft.)	0.538
Max Pipe Length (ft.)	82
Piping Length (no add'l refrigerant, ft.)	24.6
Max Elevation (ft.)	32.8

AHRI certification Ref #	9110198
--------------------------	---------



Single zone inverter mini split

MODEL: TW24HQ1A5D

TOSOT

Capacity Variation Ratio According to Temperature

Cooling

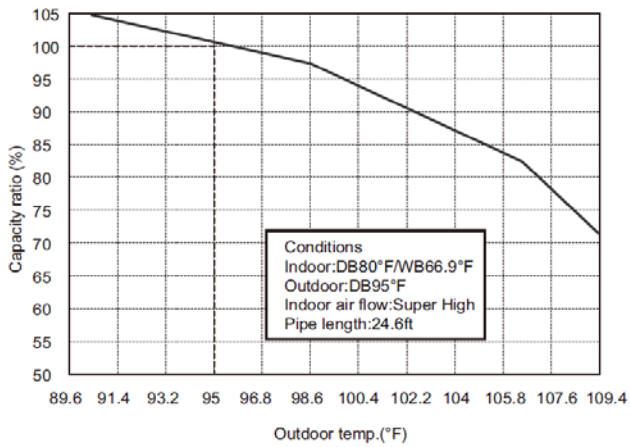

Heating

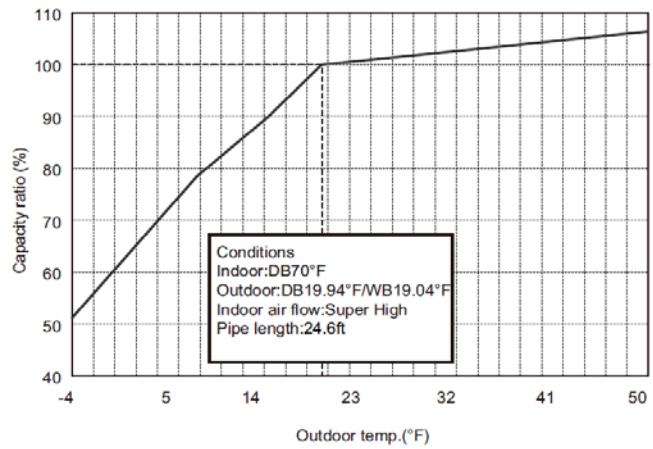

Single zone inverter mini split

MODEL: TW24HQ1A5D

TOSOT

Outline Dimension Diagram

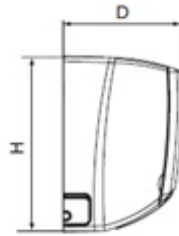
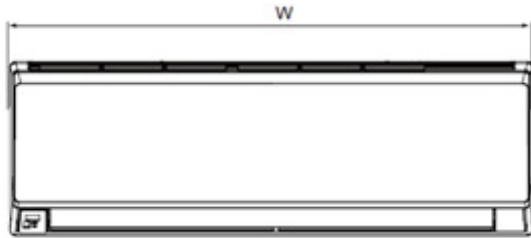

W	H	D
42 4/9	12 4/5	9 2/3

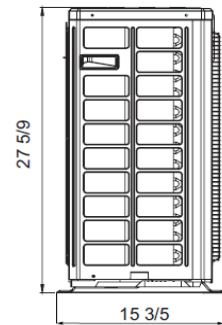
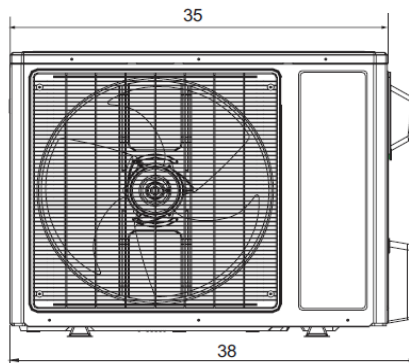
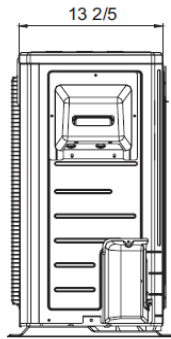
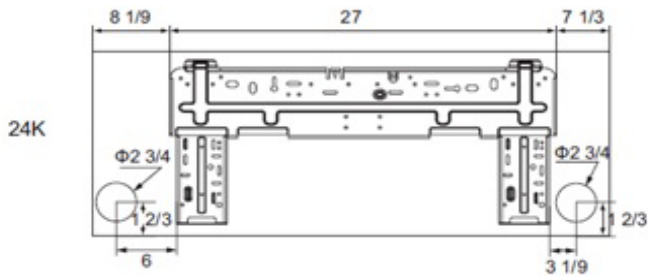

Unit: inch

GLOSSARY

SEER - Seasonal Energy Efficiency Ratio

EER - Energy Efficiency Ratio

HSPF - Heating Seasonal Performance Factor

MOP - Maximum Overcurrent Protection

MCA - Minimum Circuit Ampacity

TOSOT

5965 Chemin de la Côte de Liesse
Saint laurent, QC, Canada, H4T 1C3

Contact: +1 438 792 1956

info@tosotusa.com

www.tosotusa.com